

Human Subject Regulations Decision Charts

September 24, 2004

The Office for Human Research Protections (OHRP) provides the following graphic aids as a guide for institutional review boards (IRBs), investigators, and others who decide if an activity is research involving human subjects that must be reviewed by an IRB under the requirements of the U.S. Department of Health and Human Services (HHS) regulations at 45 CFR part 46. OHRP welcomes comment on these decision charts. The charts address decisions on the following:

- whether an activity **is research** that must be reviewed by an IRB
- whether the review may be performed by **expedited procedures**, and
- whether **informed consent** or its documentation may be waived.

Considerations

The charts are intended to assist IRBs, institutions, and investigators in their decision-making process and should not be used as substitutes for consulting the regulations. OHRP cautions that the full text of applicable regulatory provisions should be considered in making final decisions.

These charts are necessarily generalizations and may not be specific enough for particular situations. Other guidance documents are available related to specific topics, at [OHRP Policy Guidance by Topic](#). OHRP invites inquiries for additional information.

The charts do not address requirements that may be imposed by other organizations, such as the Food and Drug Administration, National Institutes of Health, other sponsors, or state or local governments.

[Chart 1](#): Is an Activity Research Involving Human Subjects?

[Chart 2](#): Is the Human Subjects Research Eligible for Exemption?

[Chart 3](#): Does Exemption 45 CFR 46.101(b)(1) (for Educational Settings) Apply?

[Chart 4](#): Does exemption 45 CFR 46.101(b)(2) or (b)(3) (for Tests, Surveys, Interviews, Public Behavior Observation) Apply?

[Chart 5](#): Does Exemption 45 CFR 46.101(b)(4) (for Existing Data, Documents, Records and Specimens) Apply?

[Chart 6](#): Does Exemption 45 CFR 46.101(b)(5) (for Public Benefit or Service Programs) Apply?

[Chart 7](#): Does Exemption 45 CFR 46.101(b)(6) (for Food Taste and Acceptance Studies) Apply?

[Chart 8](#): May the IRB Review Be Done by Expedited Procedures?

[Chart 9](#): May the IRB Continuing Review Be Done by Expedited Procedures?

[Chart 10](#): May Informed Consent Be Waived or Consent Elements Be Altered under 45 CFR 46.116(d)?

[Chart 11](#): May Documentation of Informed Consent Be Waived Under 45 CFR 46.117(c)?

Chart 1: Is an Activity Research Involving Human Subjects Covered by 45 CFR part 46?

September 24, 2004

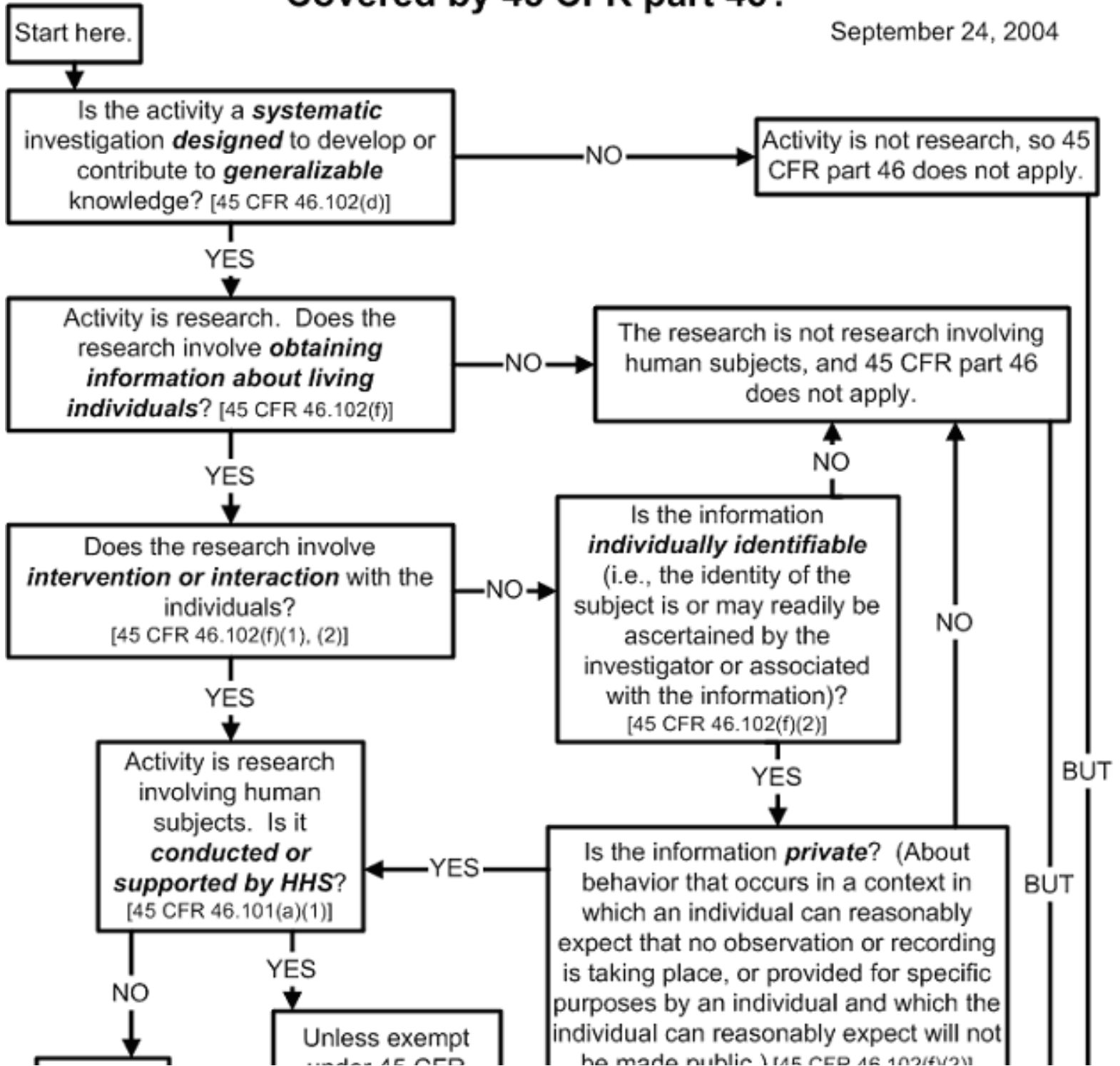

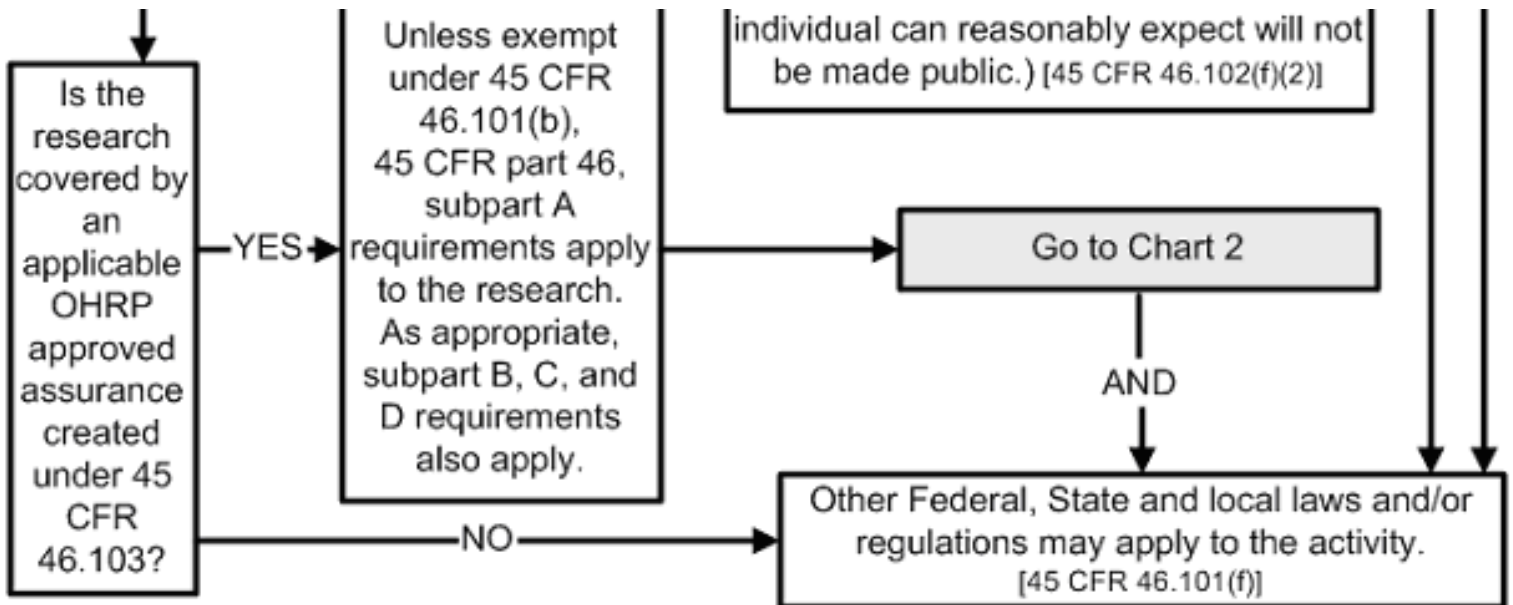
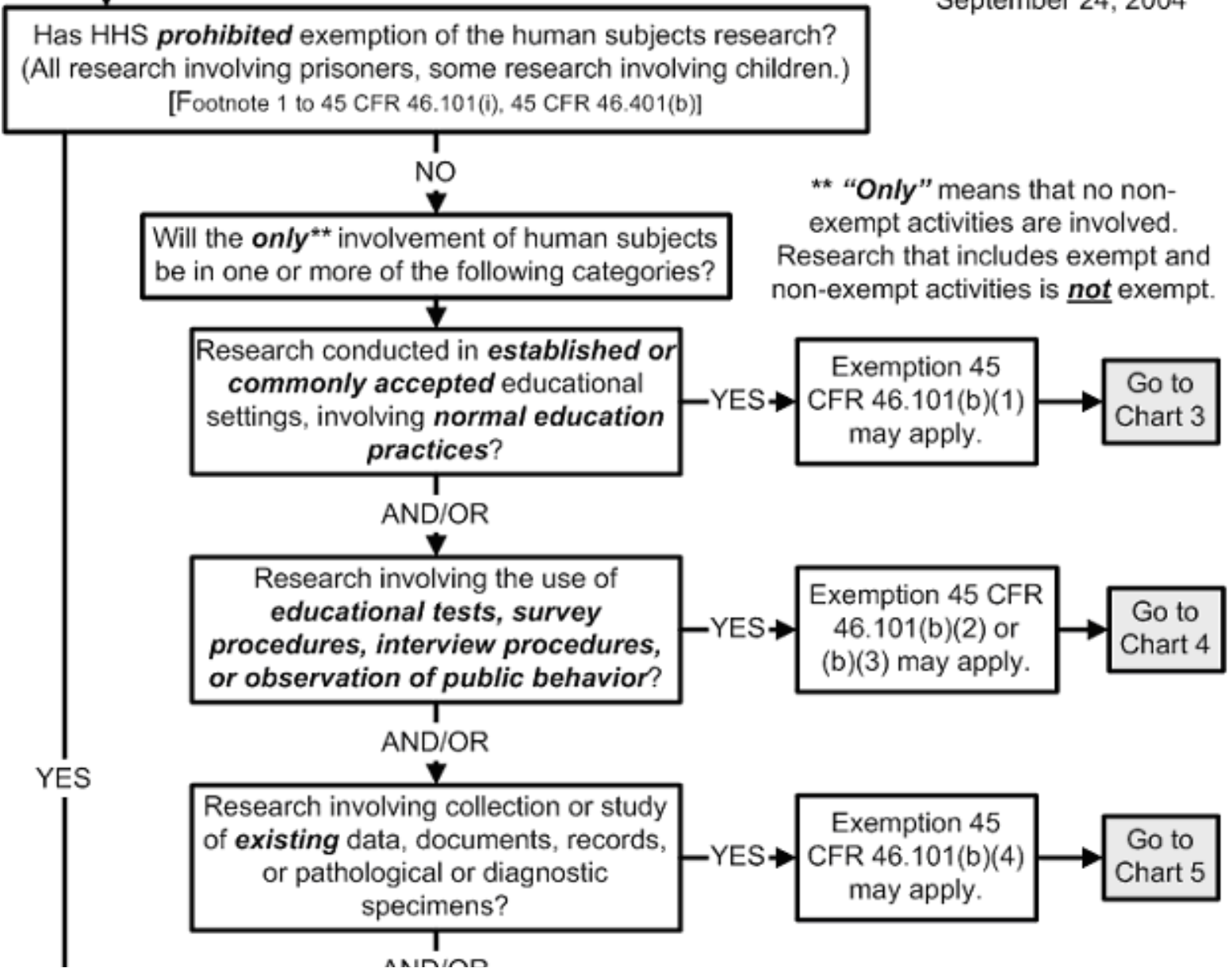

Chart 2: Is the Research Involving Human Subjects Eligible for Exemption Under 45 CFR 46.101(b)?

From Chart 1

September 24, 2004



** **"Only"** means that no non-exempt activities are involved. Research that includes exempt and non-exempt activities is **not** exempt.

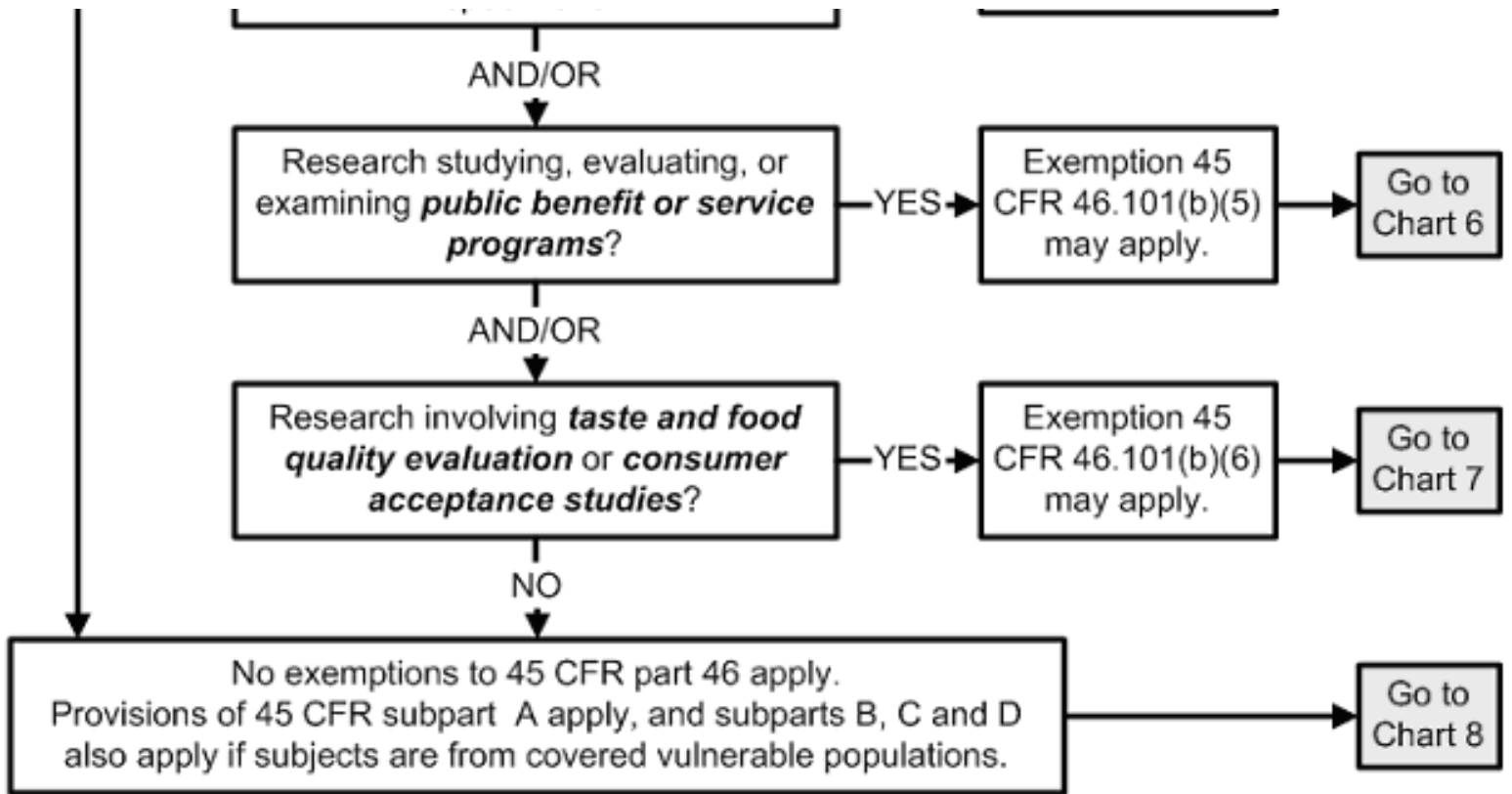
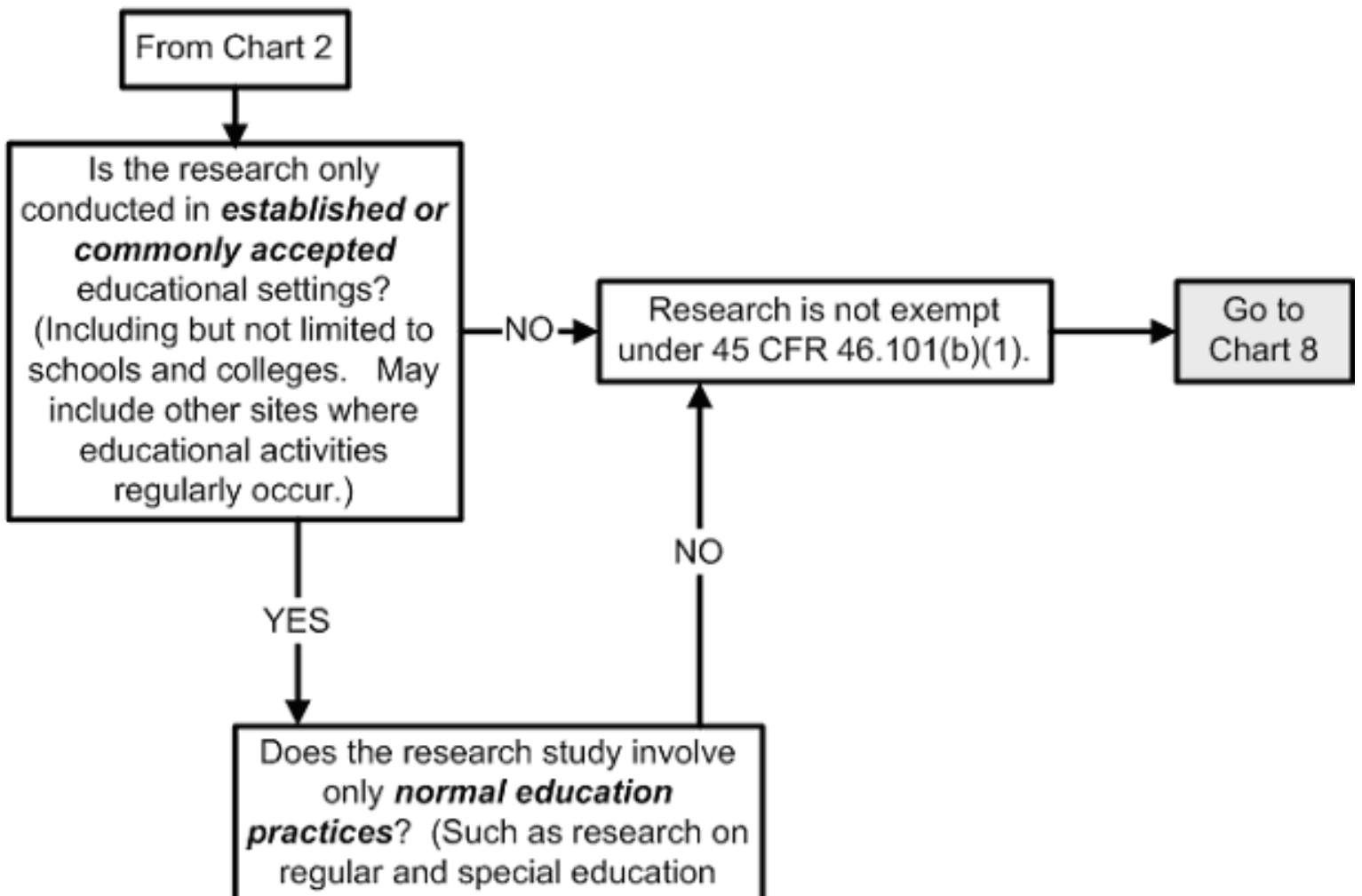
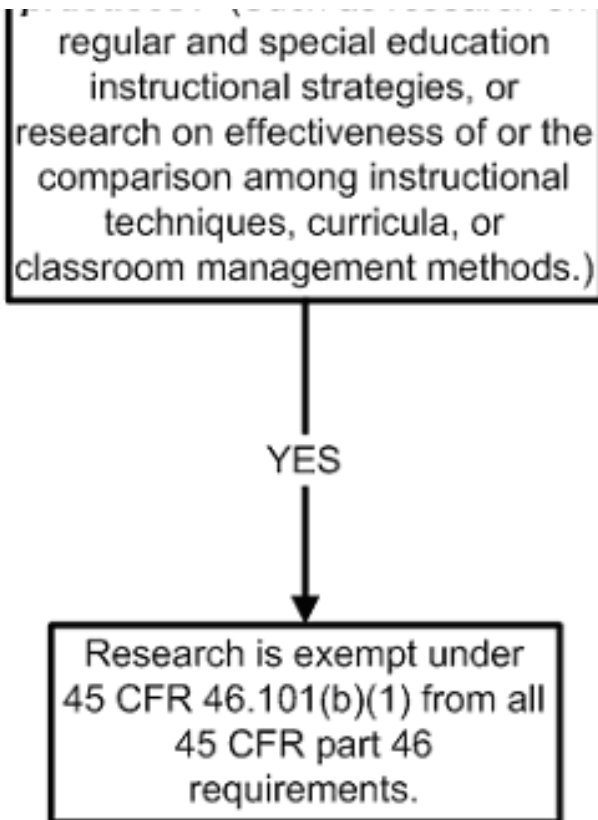

Chart 3: Does Exemption 45 CFR 46.101(b)(1) (for Educational Settings) Apply?





September 24, 2004

Chart 4: Does Exemption 45 CFR 46.101(b)(2) or (b)(3) (for Tests, Surveys, Interviews, Public Behavior Observation) Apply?

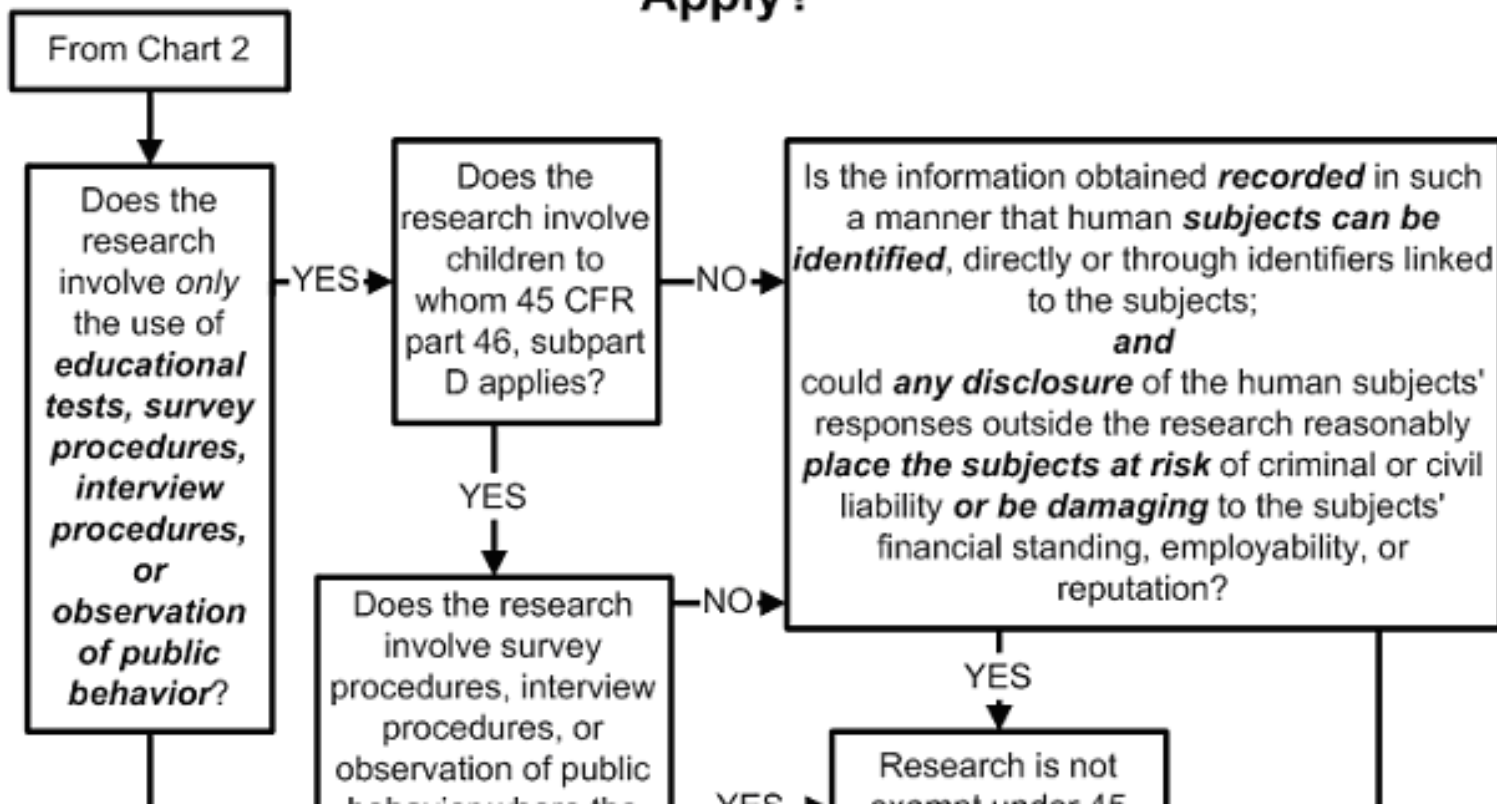

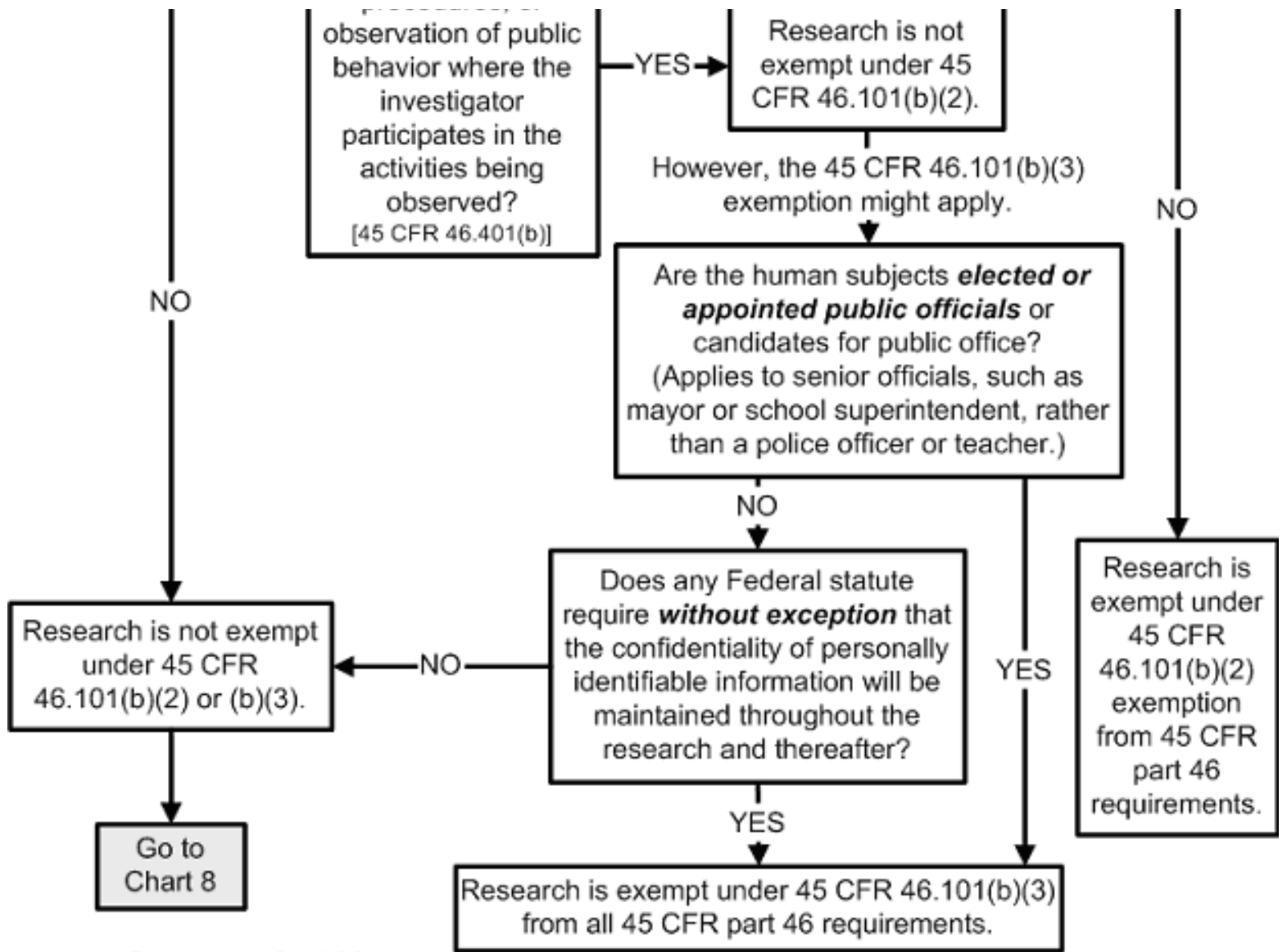

September 24, 2004

Chart 5: Does Exemption 45 CFR 46.101(b)(4) (for Existing Data Documents and Specimens) Apply?

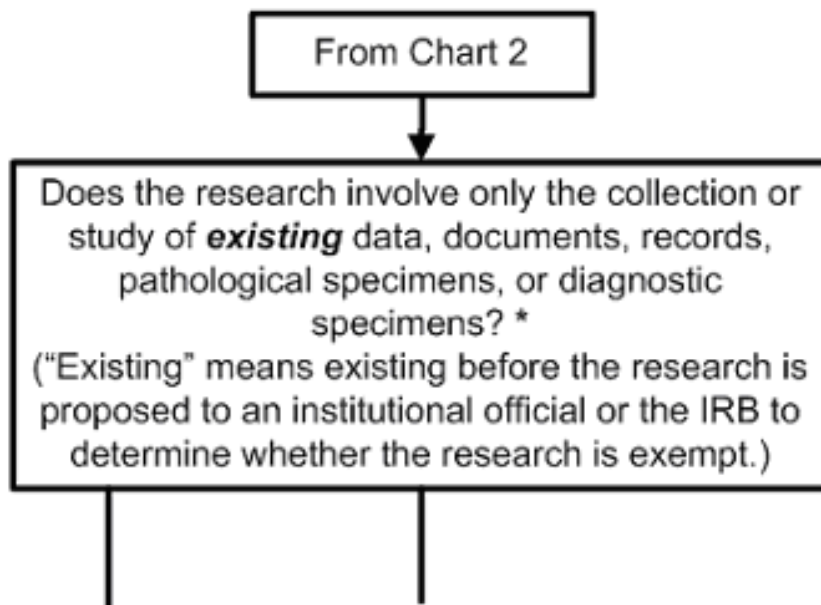

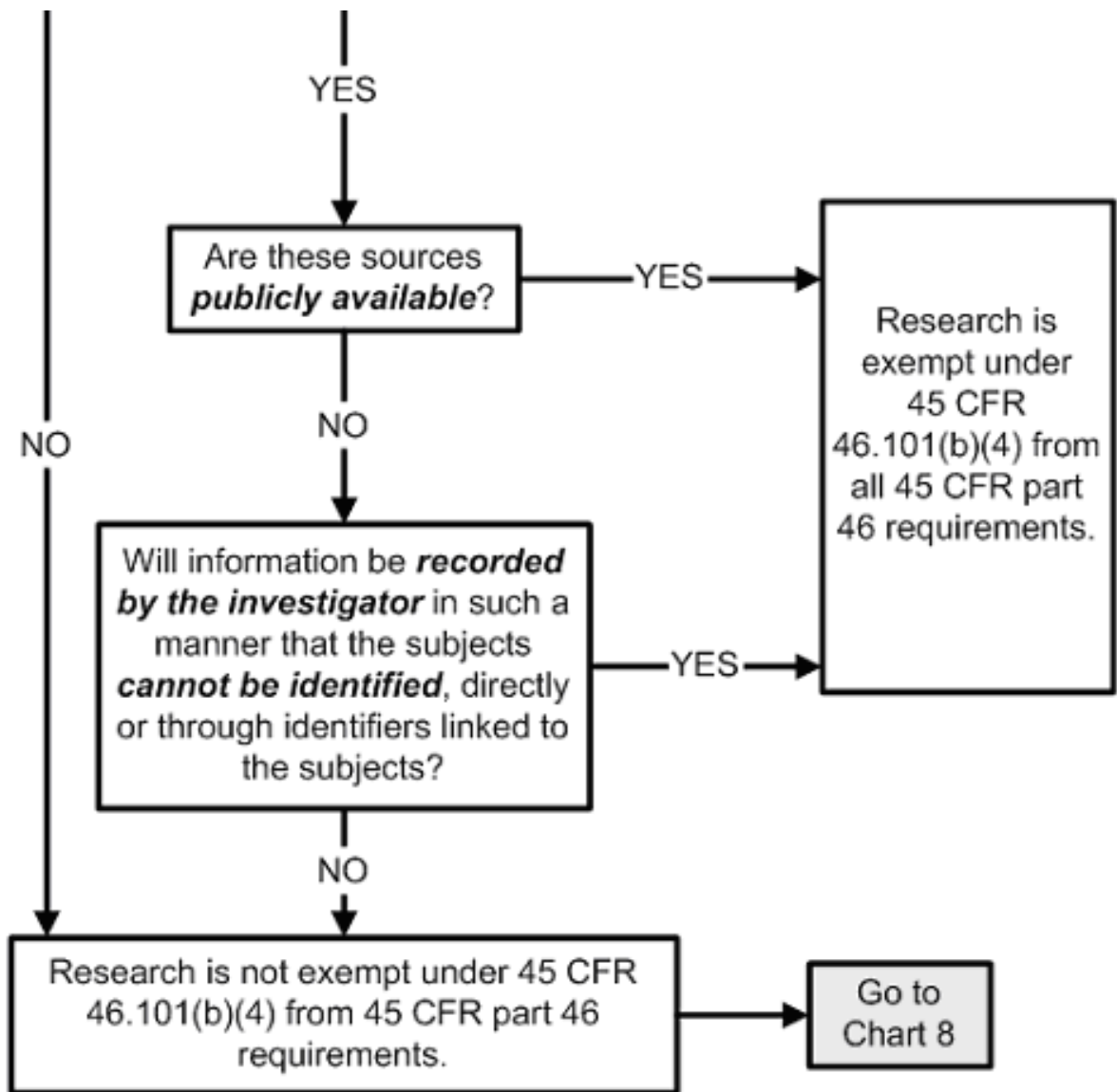

* Note: See OHRP guidance on research use of stored data or tissues and on stem cells at <http://www.hhs.gov/ohrp/policy/index.html#tissues> and #stem, and on coded data or specimens at #coded for further information on those topics.

September 24, 2004

Chart 6: Does Exemption 45 CFR 46.101(b)(5) (for Public Benefit or Service Programs) Apply?

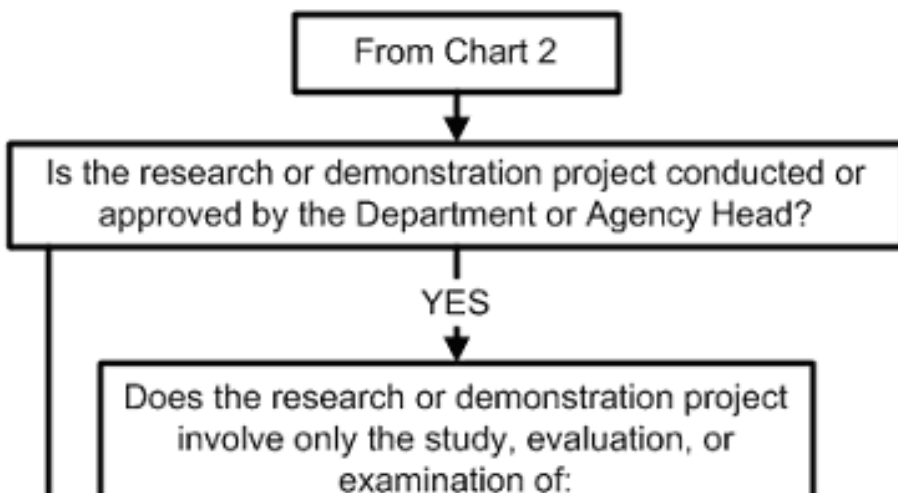

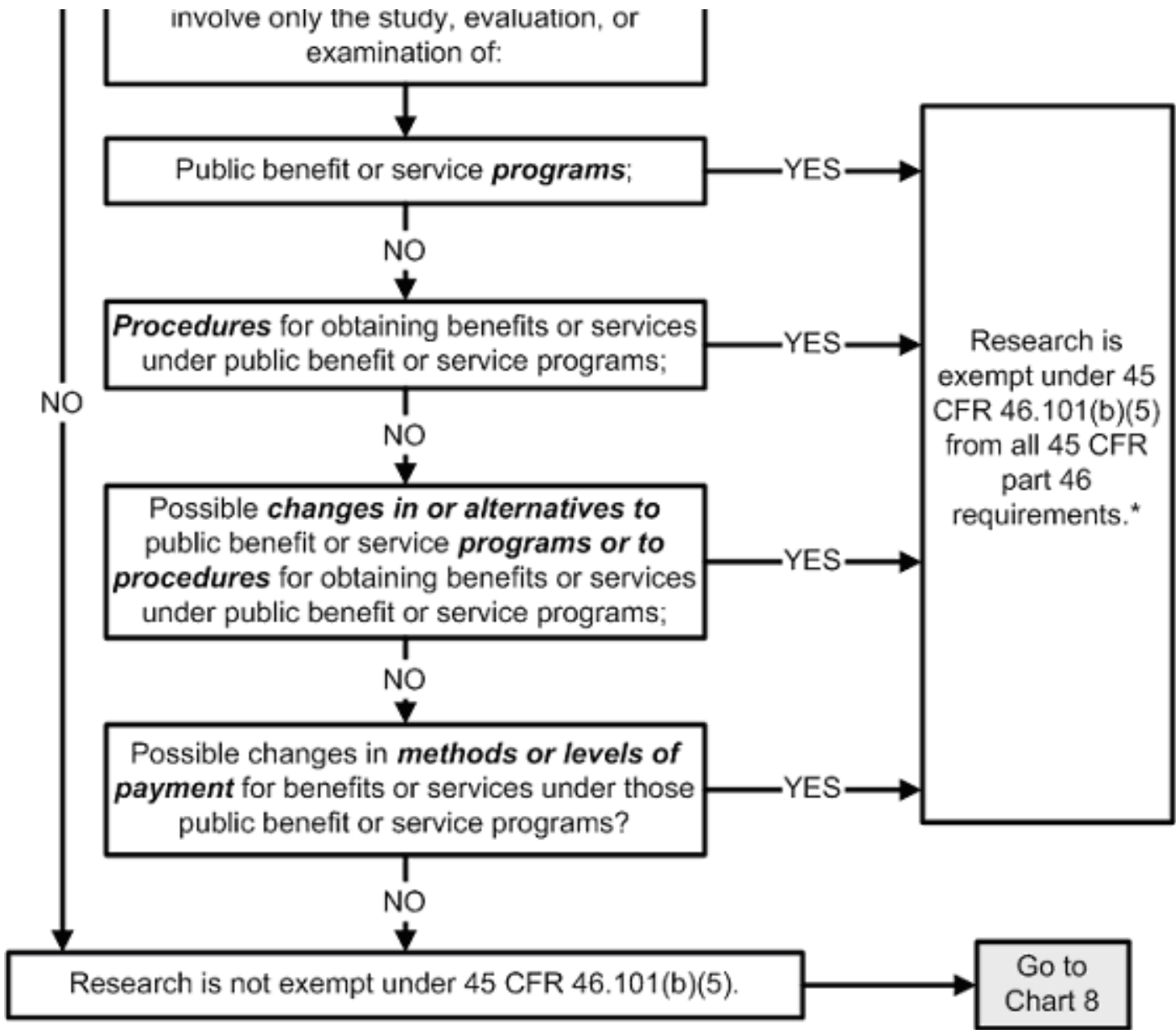

* Note: See OHRP guidance on exemptions at <http://www.hhs.gov/ohrp/policy/index.html#exempt> for further description of requirements for this exemption.

September 24, 2004

Chart 7: Does Exemption 45 CFR 46.101(b)(6) (for Food Taste and Acceptance Studies) Apply?

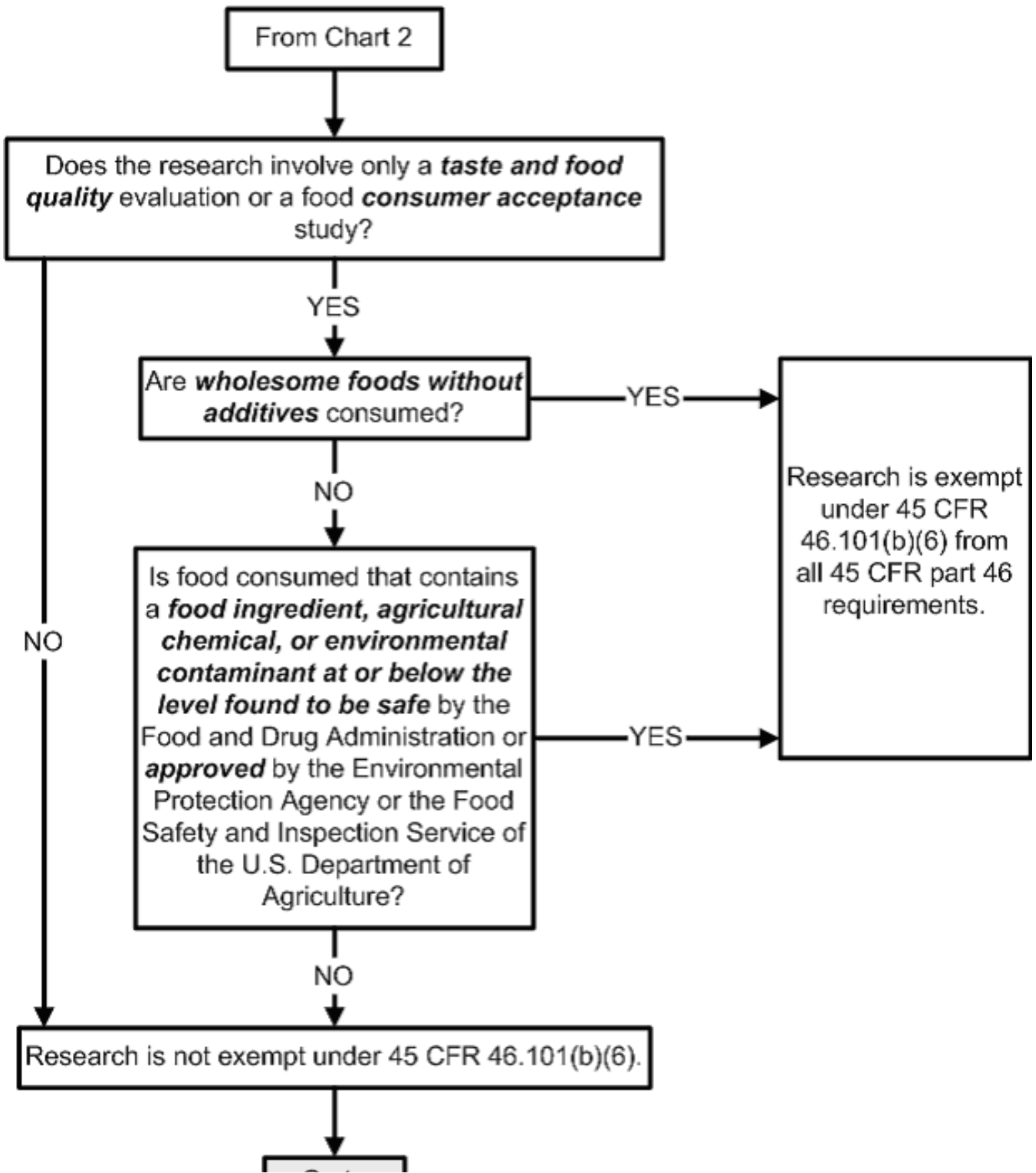

↓
Go to
Chart 8

September 24 2004

Chart 8: May the IRB Review Be Done by Expedited Procedures Under 45 CFR 46.110?*

* Note: See expedited review categories and OHRP guidance on the use of expedited review procedures at <http://www.hhs.gov/ohrp/policy/index.html#expedited> for further information on expedited review.

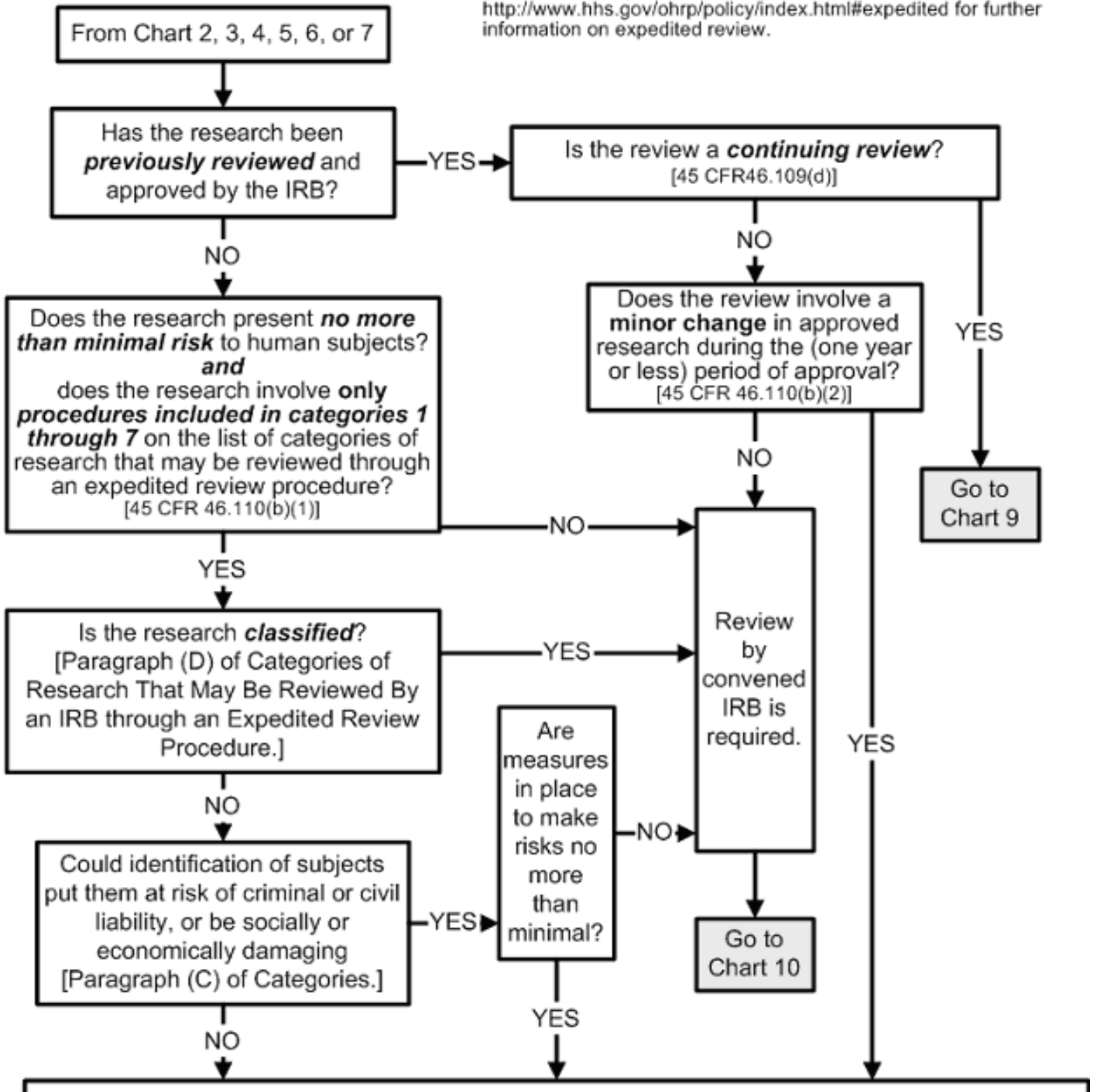

↓ ↓ ↓

Research is eligible for IRB review through expedited procedures.
 Agency head may restrict, suspend, terminate or choose not to authorize an institution's or IRB's use of the expedited review procedure. [45 CFR 46.110(d)]

September 24, 2004

Chart 9: Can Continuing Review be Done by Expedited Procedures Under 45 CFR 46.110?

* Note: See expedited review categories, OHRP guidance on the use of expedited review procedures and on continuing review at <http://www.hhs.gov/ohrp/policy/index.html#expedited> and #continuing for further information on expedited review.

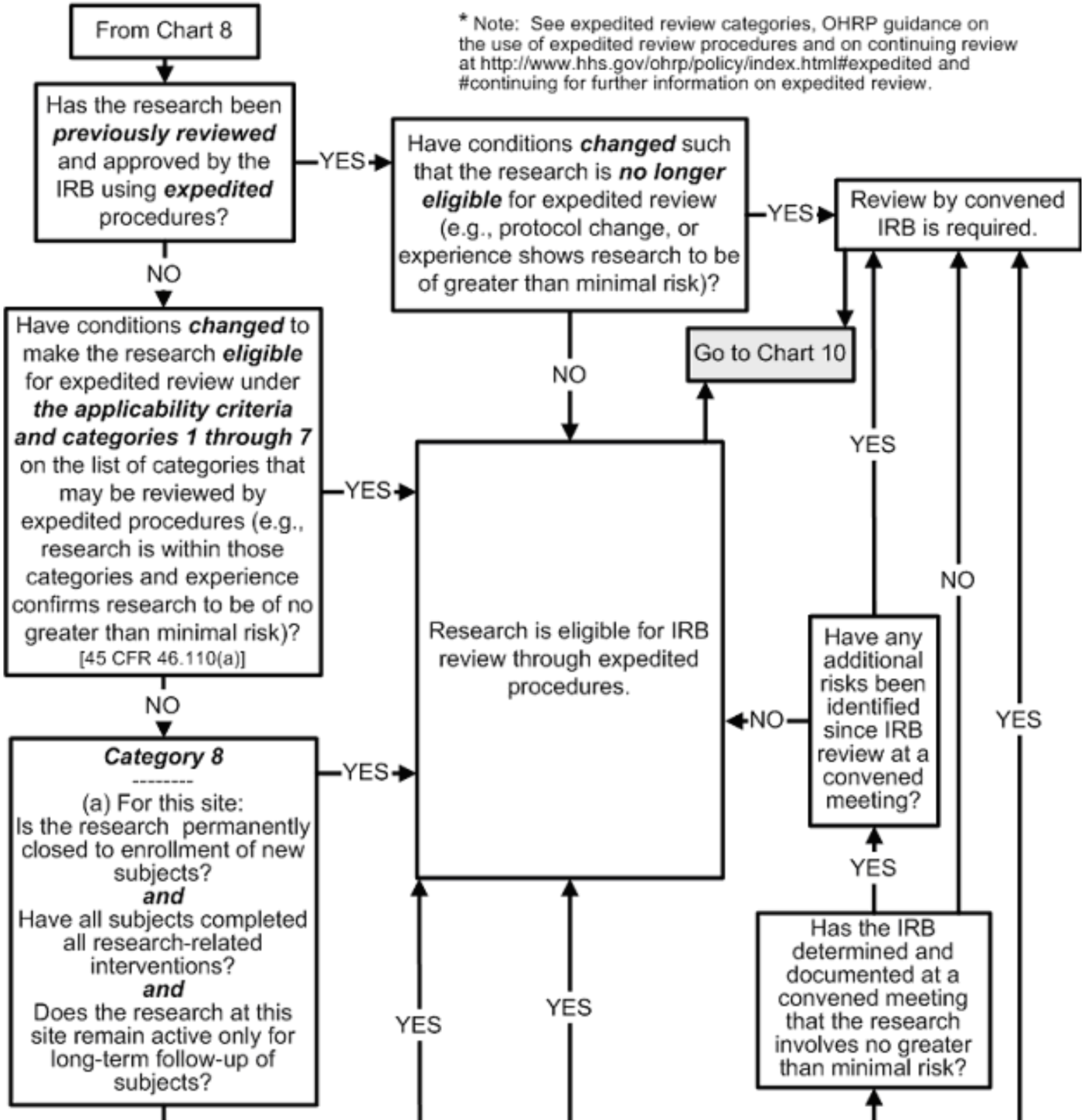

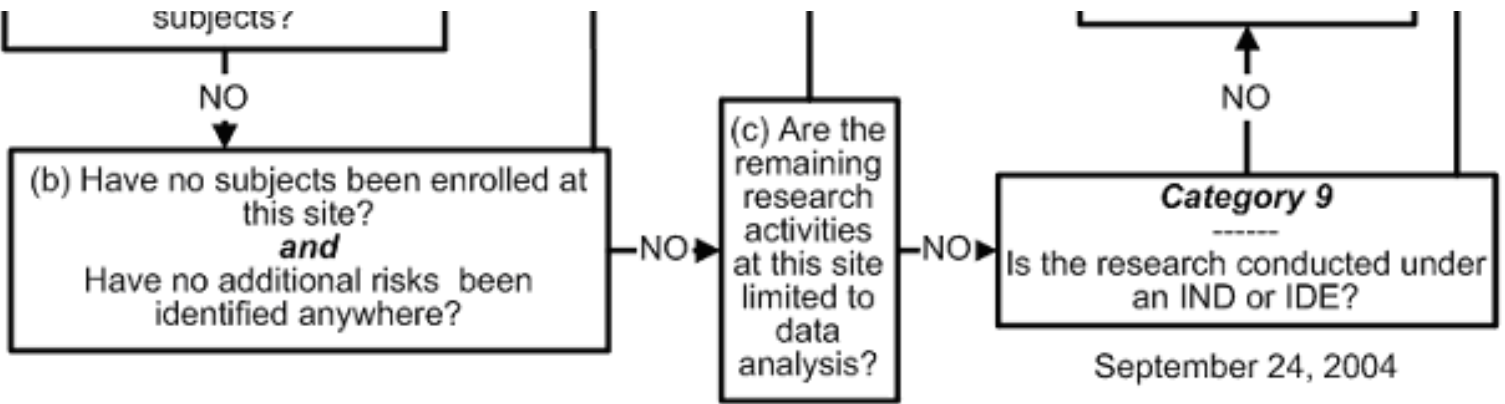

September 24, 2004

Chart 10: Can Informed Consent Be Waived or Consent Elements Be Altered Under 45 CFR 46.116(c) or (d)?**

***(Note: If subjects include children to whom 45 CFR part 46, subpart D applies, an alternative provision for waiver of parental permission might apply. [See 45 CFR 46.408(c)]*

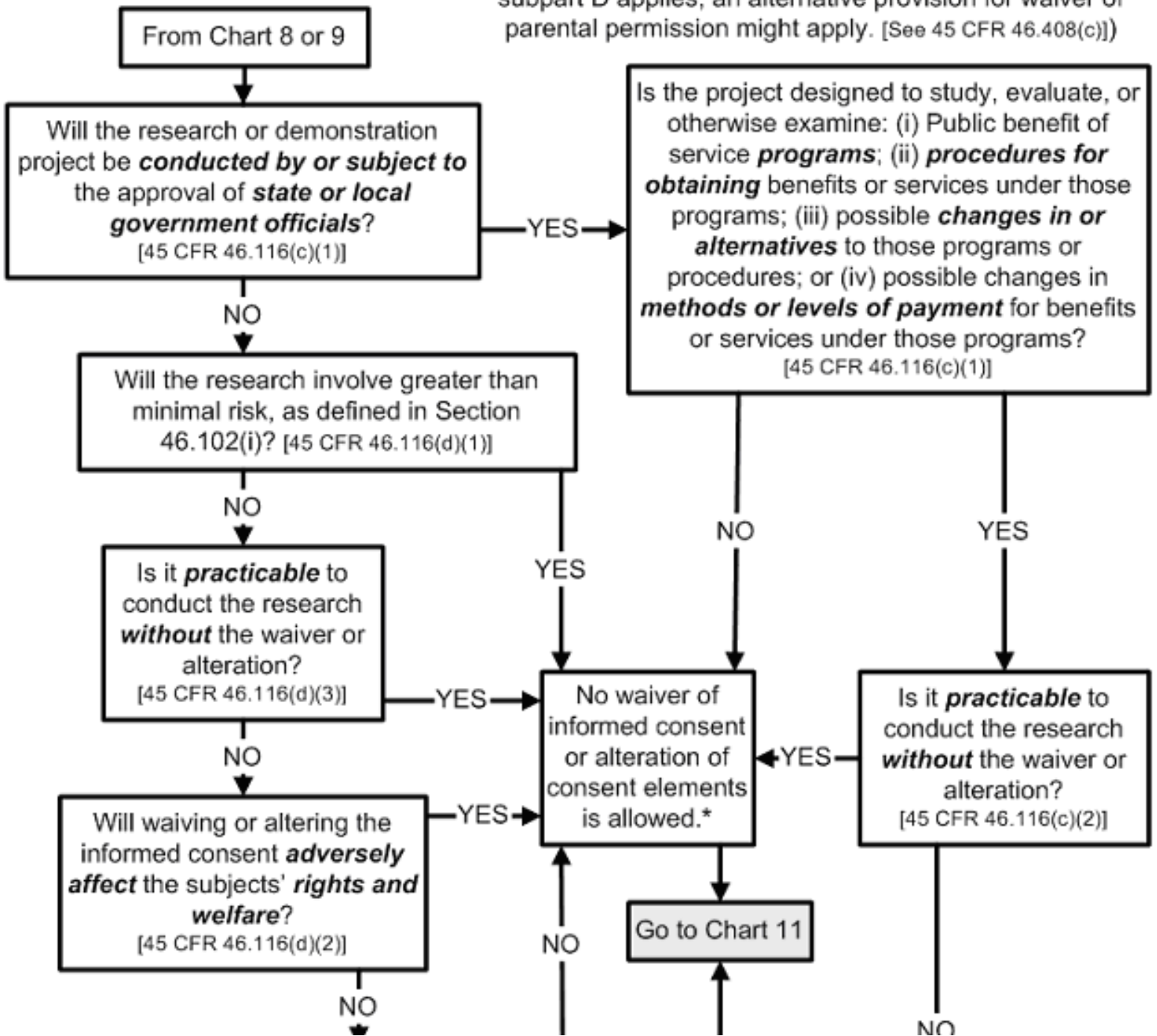

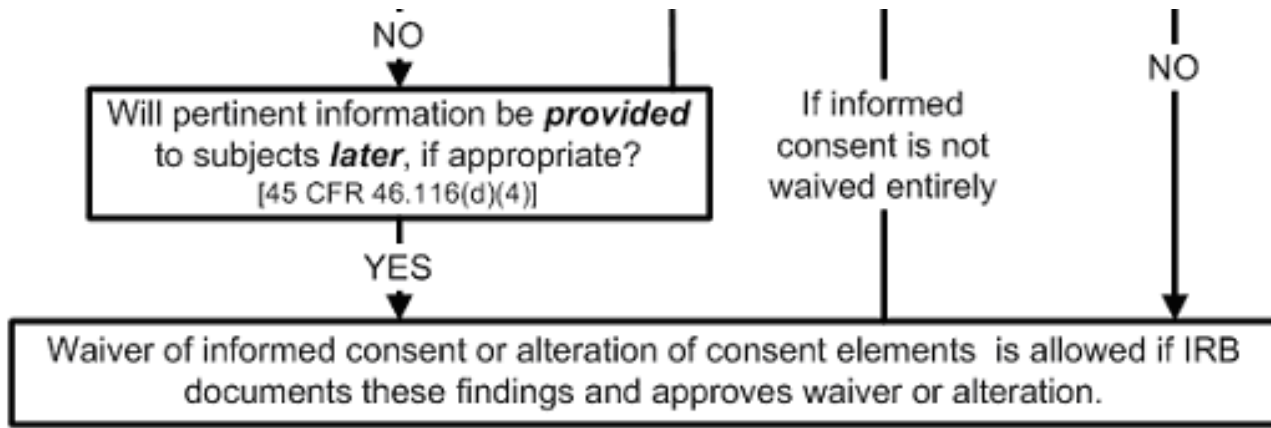

* Note: See OHRP guidance on informed consent requirements in emergency research at <http://www.hhs.gov/ohrp/policy/index.html#emergency> for further information on emergency research informed consent waiver.

September 24, 2004

Chart 11: Can Documentation of Informed Consent Be Waived Under 45 CFR 46.117(c)?

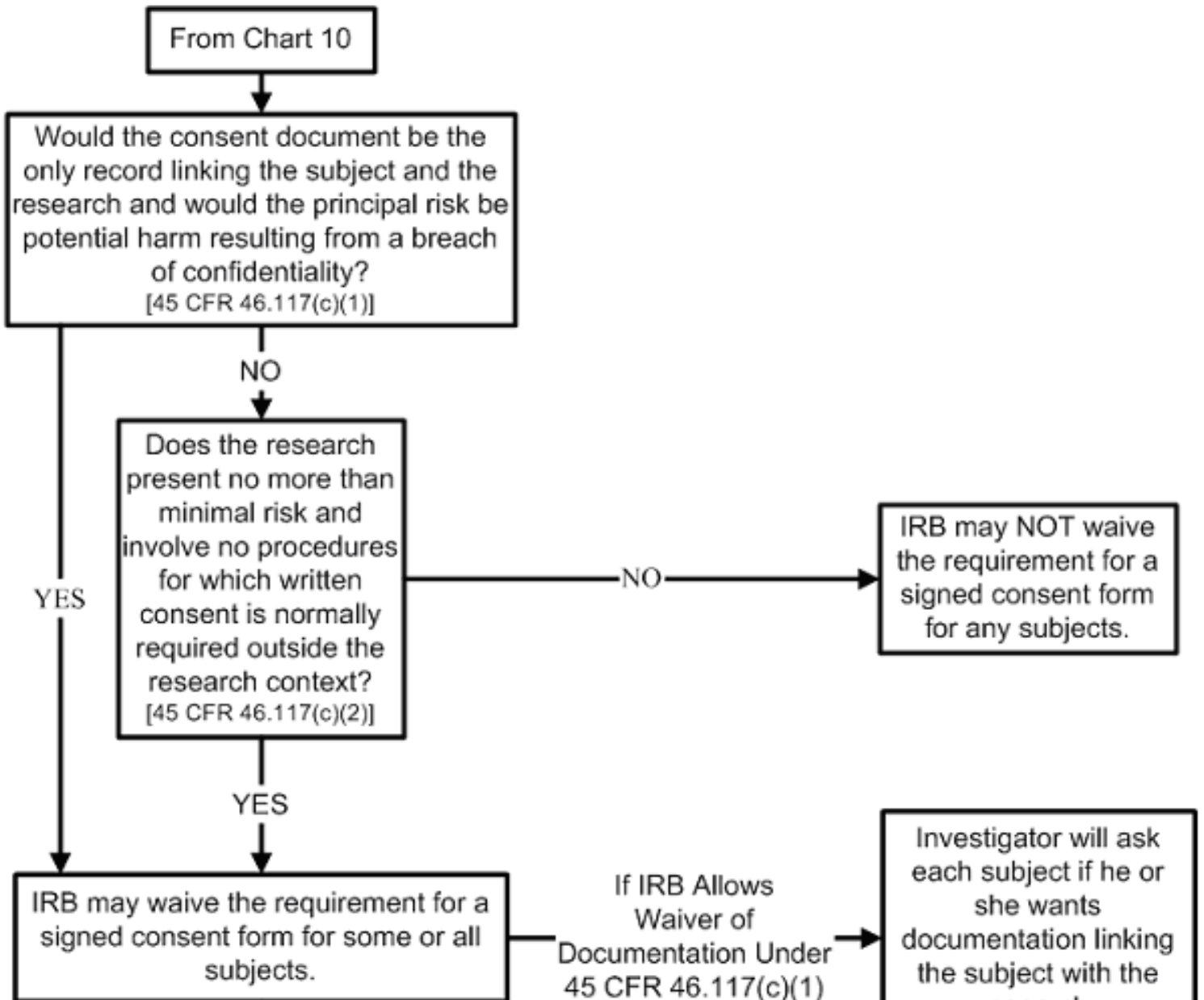

Documentation Under
45 CFR 46.117(c)(1)

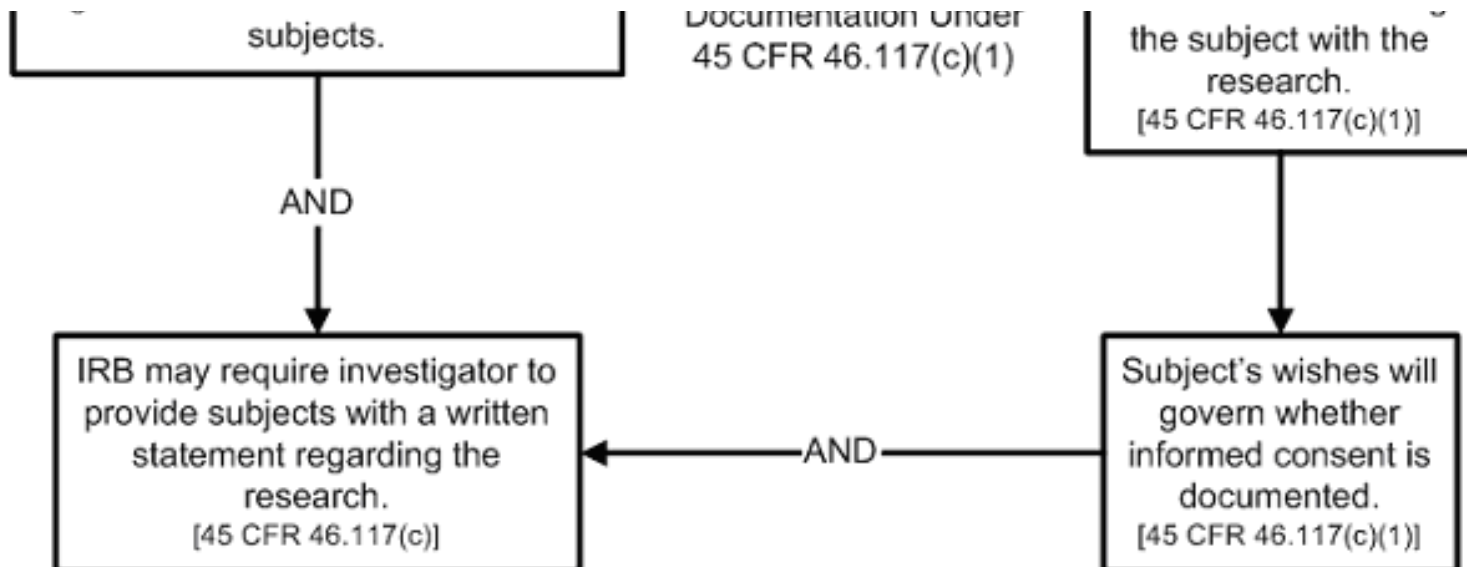

September 24, 2004